

Nickel-Titanium(NT) Coil Spring

Wire diameter

- Light 0.21mm(0.009")
- Medium & Heavy 0.23mm(0.010")

Spring diameter

- 0.9mm(0.036")

Strength

- Light(L), Medium(M), Heavy(H)

Length

- 8mm & 13mm

Hole diameter

- Ø1.5, Ø2.0, Ø2.5

Coil Spring Holder (CSH)

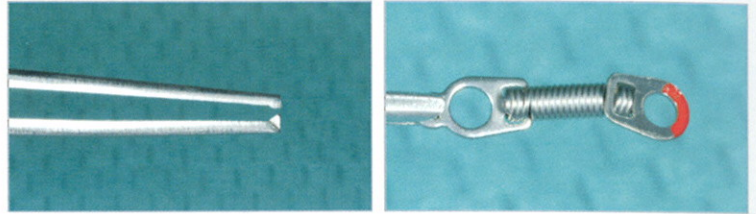







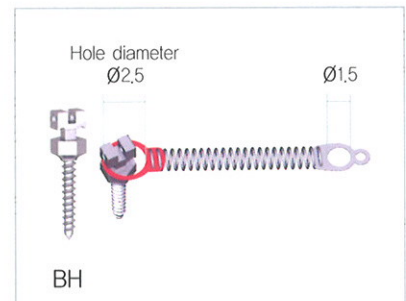
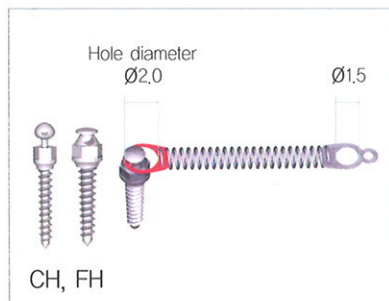
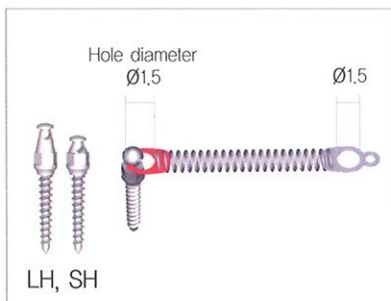













Coil Spring Case (CSC)



◀ Each case is detachable



NT Coil spring

Length	Hole Diameter (φ)	Strength		
		Light (009x036)	Medium (010x036)	Heavy(010x036)
8mm 	φ1.5	 NT15-8L	 NT15-8M	 NT15-8H
	φ2.0	 NT20-8L	 NT20-8M	 NT20-8H
	φ2.5	 NT25-8L	 NT25-8M	 NT25-8H
13mm 	φ1.5	 NT15-13L	 NT15-13M	 NT15-13H
	φ2.0	 NT20-13L	 NT20-13M	 NT20-13H
	φ2.5	 NT25-13L	 NT25-13M	 NT25-13H

NT Coil spring – Weight Range

Weight Range (8mm length)

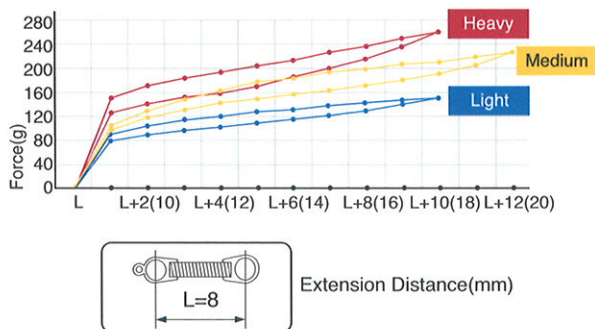

Weight Range (13mm length)

